

# SafeFume™

## Automatic Cyanoacrylate Fuming Chamber

"The World's Most Advanced Cyanoacrylate Fuming Chamber."

24 • 30 • 48 • 60 • 72XL



— SafeFume™  
CA30S

Safely Obtain Quality Latent  
Prints and Reproducible Results

Compliant with OSHA, ANSI and  
other International Standards



GSA Schedule  
Contract GS-07-9832P

**JUMP TO:**Features  
and Callouts (p.3)SafeFume™ Control  
Interface (p.4)Airflow and Multiplex™  
Filtration Technology (p.5)

Specifications (p.6)

Options and  
Accessories (p.8)**APPLICATIONS**

- State and Federal Crime Laboratories
- Crime Scene Investigation
- Law Enforcement Agencies
- Medical Examiners' Programs
- Criminal Justice Education

**INTRODUCTION**

SafeFume™ cyanoacrylate fuming chambers are designed to safely develop latent fingerprints using ethyl cyanoacrylate (CNA) vapor in a controlled environment for optimum effectiveness and safety where moisture and fuming time are critical factors. The tamper resistant compartment helps maintain the chain of custody. The unique Air Science Multiplex™ filtration system, together with professional design and unique construction features offer personnel protection during use.

The ductless filtration system requires no connection to an outside exhaust system. The automatic control system programs the fuming cycle. A versatile system of hanging rods and shelves allows proper positioning of items of evidence in the chamber.

**SafeFume™****Automatic Cyanoacrylate Fuming Chamber**

*The professionally designed automatic fuming chamber eliminates reliance on do-it-yourself systems that lack user-safety allowances and microprocessor controls needed for repeatable results.*

*The SafeFume system controls all functions from start-to-finish, permitting the investigator to initiate an unattended automatic cycle, establish the proper fuming intensity and duration, and to return upon completion to collect results.*

*Fuming time, humidity and chamber fume evacuation can be user-set to comply with internal department criteria, lab safety protocols or best practices in evidence management.*

*SafeFume CA30S and CA60T. CA30S shown with optional UV lamp.*

**DUCTLESS TECHNOLOGY:  
The Eco-friendly Choice**

Advanced carbon filtration technology offers a safe, high performance alternative to ducted cabinets for cyanoacrylate fingerprint development applications.

- **Environmental Benefits.** SafeFume cyanoacrylate fuming chambers capture cyanoacrylate vapors used in the process to prevent operator exposure and eliminate ecological impact through release into the environment.
- **Versatile.** The filtration system uses the exclusive Air Science Multiplex filtration technology.
- **Easy to Install.** SafeFume chambers are self-contained. Set-up, operation and filter maintenance are straightforward.
- **Energy Efficient.** Because filtered air is returned to the room, no demands are required of the facility HVAC capacity for make-up air.
- **Cost Effective.** Facility ductwork, HVAC and construction costs are eliminated.
- **Safe to Use.** Cabinet isolation and filtration protect users from incidental exposures to cyanoacrylate fumes.
- **Self Testing.** Electronic process monitoring assures continuous safety. An optional electronic gas sensor filter monitors carbon filter performance.





## PRODUCT FEATURES:

- A. Filter I.D. Window:** A strategically placed front cover window shows the installed filter part number and installation date for convenience and to encourage timely filter replacement.
- B. Filter Door Key:** Filter access keys prevent unauthorized removal or accidental exposure to dirty filters.
- C. Track & Wheel System:** An efficient filter clamping mechanism allows removal of main filter(s) directly to disposal bag with track and wheel system.
- D. Electrostatic Pre-Filter:** The 99.5% effective electrostatic pre-filter protects and extends the life of the main filter and can be changed without tools while unit is running to prevent operator exposure to captured contaminants.
- E. Dynamic Filtration Chamber:** The dynamic filter chamber prevents leakage of contaminated air by maintaining partial vacuum in the filter plenum.
- F. Control Panel:** The microprocessor control panel manages the Printbuster™ Pro operating sequence with control, oversight and display of all processing functions. The LCD display works with a touchpad data entry keypad to establish all operating parameters.
- G. Doors:** Tempered glass, keyed doors with aluminum frame and tamper proof seal, provide improved security, stability and ease of cleaning. (scratch-resistant glass for lasting optimum visibility).
- H. Shelving:** Standard height units include one shelf in a fixed position. Extra tall units include one shelf that is repositionable to fit two configurations.
- I. Fan:** High velocity sparkless and brushless centrifugal fan.
- J. Lighting:** Vapor-proof fluorescent light.
- K. Color:** The cabinet is white with blue door(s).
- L. Hanging Rods:** Removable and adjustable stainless steel hanging rod for proper orientation of evidence.
- M. Cool Mist Water Nebulizer/Humidifier:** Programmable to achieve preset humidity conditions quickly and accurately, using a replaceable "wicking" filter to eliminate excess cyanoacrylate from building up on the unit.
- N. Hot Plate Accelerator:** Hot plate to polymerize ethyl cyanoacrylate. Air Science also offers optional adjustable temperature hot plates to accommodate a variety of fuming techniques, including Microburst and typical Super glue methods. Hot plates are available with basic knob controls as well as advanced microprocessor controls with LED display.

## OTHER FEATURES:

- Standards Compliant:** Performance specifications and construction meet or exceed OSHA, ANSI and relevant international standards to assure operator safety.
- Construction:** Models are available in either polypropylene and epoxy coated steel or aluminum frame with plastic wall construction. Doors are tempered glass locking doors with tamper-proof seal and aluminum frame. See selection chart for specifications and dimensions. Available in 110V, 60Hz single phase electrical supply (other voltages available on request).
- Optional UV Lamp:** Activated ultraviolet light provides secondary disinfection of the interior between cases to prevent cross-contamination, ensuring integrity of the samples for DNA testing.

**Internal Chamber Cleansing:** The Internal Chamber Cleansing feature automatically activates to eliminate contamination and remove the harmful vapor from the unit. This process is especially important if the unit is used infrequently or only during certain periods of high evidence volume.

SafeFume CA30T, shown



## THE AIR SCIENCE PERFORMANCE ADVANTAGE

Safefume automatic cyanoacrylate fuming chamber includes features expressed through sound design and certified quality construction. Accessories add functional performance to meet specific applications.

- Professional Quality.** Safefume automatic cyanoacrylate fuming chambers comply with current technical and safety regulations.
- Multiplex Filtration.** The Air Science Multiplex Filter offers high performance and safety.
- Industrial Components.** The cabinet frame and work surfaces are durable and chemically resistant.
- Reliability.** Internal systems are isolated from fumes, extending product life.



Air Science Safefumes use energy-efficient ebmpapst™ brand centrifugal blowers for long life and dependable performance.

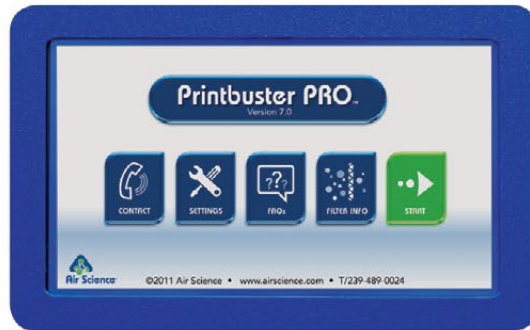

## AIR SCIENCE PRINTBUSTER™ PRO LCD INTERFACE TECHNOLOGY

Printbuster Pro is the industry's first use of touchscreen technology offering a simple, easy-to-use solution delivering repeatable results every time. The automatic latent fingerprint development cycle manages the following:

- Relative humidity setpoint. Relative humidity is established via a water-filled nebulizer/humidifier.
- Cabinet temperature display.
- Door status with lock alarm.
- Circulation fan on/off.
- Hot plate on/off. The hot plate accelerator polymerizes ethyl cyanoacrylate for a specific time interval.
- Processing time.
- Purge cycle time. Fumes are removed from the chamber through the Multiplex filtration system via a carbon filter; air is safely exhausted to the room.
- Emergency stop.
- Filter condition. An optional electronic gas sensor emits an audible and visual warning when the main filter must be changed.

The microprocessor control panel manages the Printbuster Pro operating sequence with control, oversight and display of all processing functions. The LCD display works with a touchpad data entry keypad to establish all operating parameters.

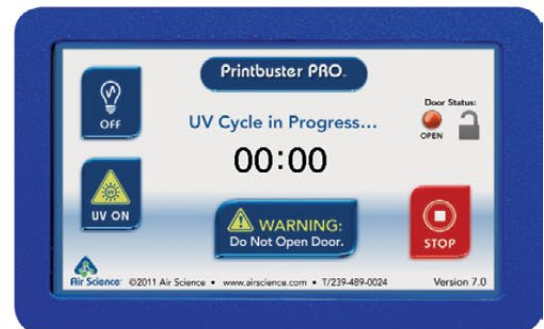

**Key Performance Advantages**

Air Science Safefume™ chambers provide key operational advantages that make evidence processing safer, easier and more accurate.

- **Internal Chamber Cleansing.** Operators are protected from harmful cyanoacrylate vapor out-gassing when the unit is not in use. Even if the unit is not running, internal surfaces may still be contaminated from the previous processing cycle.
- **Fuming Delay.** Cyanoacrylate fuming achieves maximum results under 70% to 80% humidity. Air Science has developed a hot plate fuming delay that only activates at the user-determined chamber humidity, ensuring better results and clearer print impressions on the first fuming.
- **Cool Mist Nebulizer.** Open steam reservoir humidifiers are slow and inaccurate, while faster ultrasonic humidifiers remain sensitive to residue buildup on the water tank. The Air Science Cool Mist Nebulizer can be programmed to achieve preset humidity conditions quickly and accurately, using a replaceable “wicking” filter to eliminate excess cyanoacrylate from building up on the unit.
- **Adjustable Temperature Hot Plate.** (Optional) The Safefume™ is versatile, offering optional hot plates to cater to a variety of fuming techniques, including Microburst and typical Super glue methods.

**multipleX**

**MULTIPLEX™ FILTRATION TECHNOLOGY**

Multiplex Filtration consists of a pre-filter and main filter to create a combination of chemical and physical architecture customized to each application. The mechanical design enhances safety, convenience and overall value.

- The electrostatic pre-filter is accessible from within the cabinet.
- A filter clamping mechanism allows for the filter to be easily installed and ensures an even seal at the filter peripheral face at all times to prevent bypass leakage.
- The filter chamber prevents contaminated air from contacting internal cabinet mechanisms.
- The main filter number and installation date are displayed in a front-access window.

The Air Science carbon filtration technique is based on enhanced, activated carbon particle formulations from specially selected, naturally occurring raw material superior to wood or other organic sources. The carbon is treated to attain the proper porosity and aggregate surface area and to react with several ranges of aerosolized chemicals moved through the filter by an air handling blower.

- The carbon filter is a self-contained assembly sized to fit the specified product model number, and configured to optimize airflow across 100% of the filter surface area for maximum efficiency, prolonged filter life, optimal diffusion and saturation capacity, and user safety.



**SAFEFUME™ AIRFLOW PATTERN**

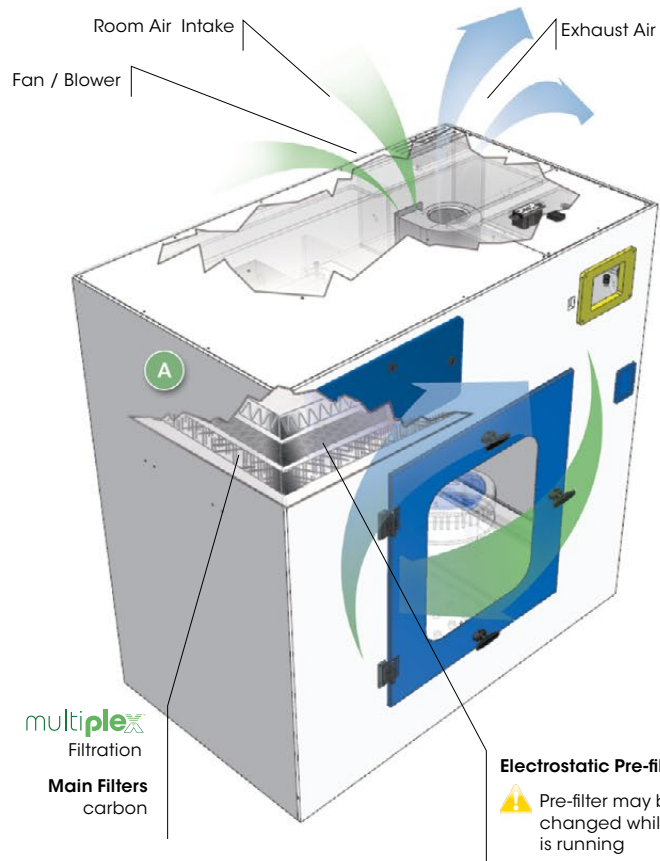

**Electrostatic Pre-filter**  
 ⚠️ Pre-filter may be changed while unit is running

- Safefume CA48S, shown with Multiplex Filtration System.
- **A.** The main filter (activated carbon, selected for capture of cyanoacrylate vapors), is easy to replace, no tools required. The filter clamps tightly against the filter gasket to prevent filter bypass and maintain filter integrity.
- Air Science is the single source supplier for all pre-filters and carbon filters used in its products, plus those of many other manufacturers.

**STANDARDS & COMPLIANCE**

Quality Management Systems	ISO 9001
Chemical Fume Containment	ANSI/ASHRAE 110 1995
Carbon Filter Efficiency	BS 7989-2001 AFNOR NFX 15-211
Electrical Safety	UL-C-61010-1 ROHS Exempt under EEE Category 9
Product Design	ANSI Z 9.5-2003 ANSI Z 9.7-1998
OSHA, Occupational Safety and Health Administration	OSHA Standard -29 CRF, Safety and Health Regulations for General Industry, 1910.1450: Occupational exposure to hazardous chemicals in laboratories. Part B, definition, laboratory type hood. All Air Science products meet this definition.
Environment	ISO 14001 Energy Star Partner

This Product Exceeds OSHA, ANSI and Other International Standards.

**SAFEFUME™ SERIES FEATURES & BENEFITS**

The Air Science automatic Safefume cyanoacrylate fuming chambers safely and automatically develop latent fingerprints on most non-porous surfaces using the proven technique of exposure to ethyl cyanoacrylate vapor. Evidence is positioned in the chamber with a flexible system of hanging rods and shelves. A fully automatic system controls and monitors the process.

- Choose from multiple sizes, from bench top to floor standing.
- Multi-chamber cabinets available.
- Caster wheels standard on all models except bench top series.
- Optional UV Lamp decontamination.
- Optional side and rear windows for 360° view of development.



**DNA Decontamination UV Lamp System**  
(optional) provides secondary disinfection of the interior between cases to prevent cross-contamination, ensuring integrity of samples for DNA testing.

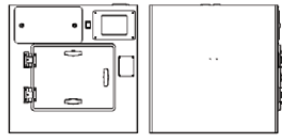

**CA24S**  
(front & side view)

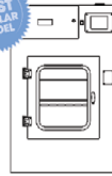

**CA30S**

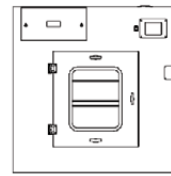

**CA48S**

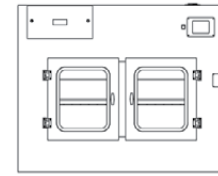

**CA60S**



(side view)

MODEL	DIMENSIONS			WEIGHT (lbs/Kg)	
	Internal Height	External (W x D x H)	Shipping (W x D x H)	Net	Ship

**Benchtop Models**

CA24S	12.75" 325 mm	24" x 17.25" x 24" 610 x 441 x 610 mm	40" x 40" x 55" 1016 x 1016 x 1397 mm	156 / 71	200 / 91
CA30S	36" 914 mm	30" x 28" x 48" 762 x 711 x 1220 mm	40" x 40" x 55" 1016 x 1016 x 1397 mm	175 / 79	215 / 98
CA48S	36" 914 mm	48" x 28" x 48" 1219 x 711 x 1220 mm	58" x 40" x 55" 1473 x 1016 x 1397 mm	306 / 139	346 / 157
CA60S	36" 914 mm	60" x 28" x 48" 1524 x 711 x 1220 mm	65" x 40" x 55" 1651 x 1016 x 1397 mm	369 / 167	407 / 185

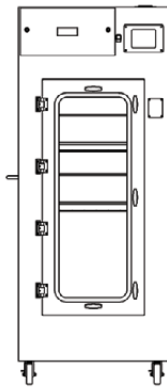

**CA30T**

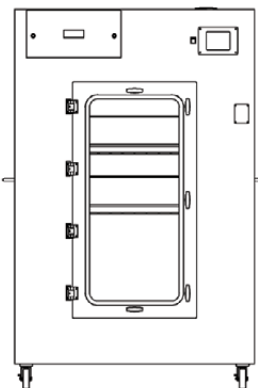

**CA48T**

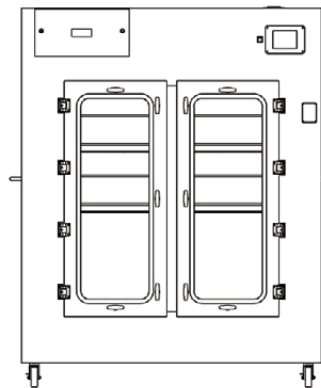

**CA60T**



(side view)

**Tall Models**

CA30T	57.24" 1454 mm	30" x 28" x 74.88" 762 x 711 x 1902 mm	40" x 40" x 91" 1016 x 1016 x 2311 mm	271 / 123	316 / 143
CA48T	57.24" 1454 mm	48" x 28" x 74.88" 1219 x 711 x 1902 mm	58" x 40" x 91" 1473 x 1016 x 2311 mm	327 / 148	367 / 166
CA60T	57.24" 1454 mm	60" x 28" x 74.88" 1524 x 711 x 1902 mm	70" x 40" x 91" 1778 x 1016 x 2311 mm	382 / 173	447 / 203

Specifications are subject to change without notice.

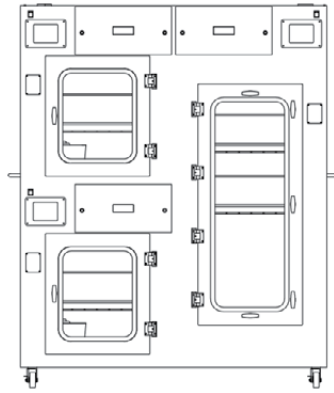

CATRI

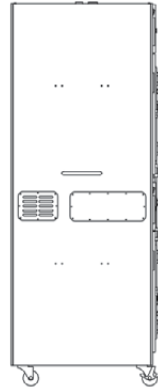

(side view)

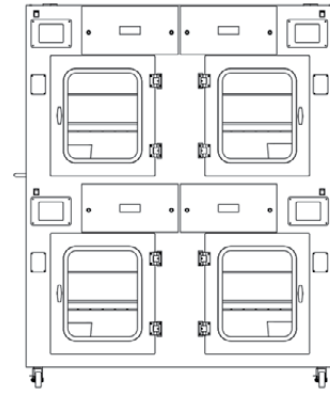

CAQUAD



(side view)

MODEL	DIMENSIONS			WEIGHT (lbs/Kg)	
	Internal Height	External (W x D x H)	Shipping (W x D x H)	Net	Ship
<b>Standard Triplex Model (3 Chambers*)</b>					
CATRI	2 @ 36" 914 mm	1 @ 65.75" 1668 mm	60" x 28" x 82.25" 1524 x 711 x 2090 mm	70" x 40" x 91" 1778 x 1016 x 2311 mm	402 / 182 467 / 212
<b>Standard Quad Model (4 Chambers*)</b>					
CAQUAD	4 @ 36" 914 mm		60" x 28" x 82.25" 1524 x 711 x 2090 mm	70" x 40" x 91" 1778 x 1016 x 2311 mm	418 / 189 476 / 216
<b>Aluminum Frame Walk-in Model</b>					
CA72XL	1 @ 80" 2032 mm		72" x 48" x 86" 1829 x 1200 x 2184 mm	80" x 54" x 95" 2032 x 1372 x 2413 mm	825 / 374 968 / 439

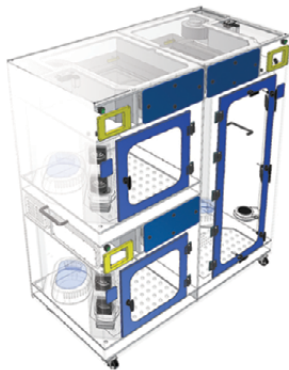

The Safefume CATRI three-chamber, floor model fuming chamber includes three individual compartments with independent controls and ductless carbon filters.

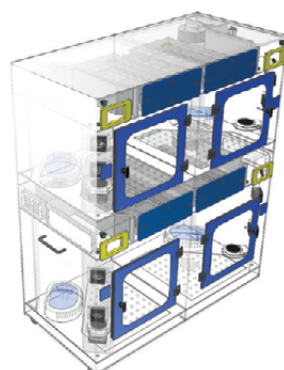

The Safefume CAQUAD four-chamber, floor model fuming chamber includes four individual compartments with independent controls and ductless carbon filters.



The Safefume CA72XL is a high volume, stand alone, fingerprinting chamber designed for departments that must process large amounts of evidence on a regular basis. Large items such as automobile doors, tires, bicycles, etc. can be easily processed in this unit.

This model offers the same functionality as our smaller versions including the Printbuster Pro control system.





## PRODUCT SPECIFICATIONS

Safefume™ Models	CA24S CA30S CA48S CA60S	CA30T CA48T CA60T	CATRI	CAQUAD	CA72XL
Airflow CFM	145	145	145	145	145
Noise, dBA, 1 meter	< 50	< 50	< 50	< 50	< 50
Construction	White polypropylene and epoxy coated steel.			Aluminum frame with tempered glass walls.	
Shelving	single, fixed position	single, two-position	single, per compartment		optional
Lighting	<... (2) 15 watts ...>				
Blower	<... ebmpapst™ centrifugal fan. ...>				
Electrical Switches	<... Main On/Off ...>				
Monitoring	<... Complete full monitoring of all functions. ...>				

## Filter Specifications

Pre-Filter, Electrostatic 1 lb. / .45 kg (nominal)	1	1	3	4	1
Main Filter, 22 lbs / 9.6 kg	1	1	3	4	1

## OPTIONS &amp; ACCESSORIES

Safefume™ Model		CA24S	CA30S	CA48S	CA60S
Option	Description	Part Number			
Heavy Duty Base Stand	Provides a lower storage half shelf; accommodates wheelchair access. Locking casters fix the chamber in place. 34" tall.	P5-CART	P10XL-CART	P20-CART	P25-CART
Enclosed Base Cabinet	Provides storage space below the chamber. (Specify: yellow, blue or white color and wheels or leveling feet)	P5-ENCB	P10XL-ENCB	P20-ENCB	P25-ENCB
DNA Decontamination UV lamp*	A UV lamp is available for overnight decontamination of interior surfaces. The UV kit includes a timer and door micro switch interlock. The UV operation must comply with local codes and facility safety practices. Contact your facility safety officer for details.	CA-UV	CA-UV	CA-UV	CA-UV
Basic Hot Plate	Basic hot plates heat up to 400°C and offer basic temperature control knobs with 1 to 10 dial markings. Maximum capacity of 1000mL. All aluminum construction. Available in 110V or 230V configurations.	BHOTPLATE110 or BHOTPLATE230	BHOTPLATE110 or BHOTPLATE230	BHOTPLATE110 or BHOTPLATE230	BHOTPLATE110 or BHOTPLATE230
Advanced Hot Plate	Advanced hot plates heat up to 400°C and offer microprocessor controls and LED display with enhanced safety features. Low profile design has a maximum capacity of 600mL. All aluminum construction. Available in 110V or 230V configurations.	AHOTPLATE110 or AHOTPLATE230	AHOTPLATE110 or AHOTPLATE230	AHOTPLATE110 or AHOTPLATE230	AHOTPLATE110 or AHOTPLATE230
Automatic Lock-Out System	Safety supplement to standard key lock system. Automatic lock-out system is interconnected to the main control system to prevent premature or unauthorized access to interior chamber.	EM-LOCK	EM-LOCK	EM-LOCK	EM-LOCK
Electronic Lock	Prevents accidental door opening during fuming cycle	E-LOCK	E-LOCK	E-LOCK	E-LOCK
ADA Lock	Accommodates ADA compliance for ergonomic access and operation.	ADA	ADA	ADA	ADA

\* Includes timer, and door micro switch. Safety precautions must be followed.



120 6th Street • Fort Myers, FL 33907  
T/239.489.0024 • Toll Free/800.306.0656 • F/800.306.0677  
www.airscience.com

